













TITANIUM 2000

CE





-  Smontagomme elettroidraulico per rapido smontaggio e montaggio pneumatici con e senza camera d'aria di autocarri, autobus e veicoli industriali, con cerchi a canale e ad anello elastico.
-  **Easy demounting and mounting electro-hydraulic tyre changer for trucks, buses and industrial vehicles tubed or tubeless, with groove rim and split ring rim.**
-  Elektrohydraulische Reifenmontiermaschine für schlauchlose und Schlauchreifen für Lkw, Busse und Nutzfahrzeuge, mit Tiefbett- oder Sprengingfelgen.
-  Démonte-pneus électro-hydraulique pour camion pour le montage et le démontage de roues de camions, bus et véhicules industriels avec ou sans chambre à air, avec jante à rainure ou à bague fendue.
-  Desmontadora electrohidráulica para desmontaje y montaje rapido de neumáticos de camiones, autobuses y vehiculos industriales, con y sin cámara de aire, para llantas canal o llantas con anillo elástico.



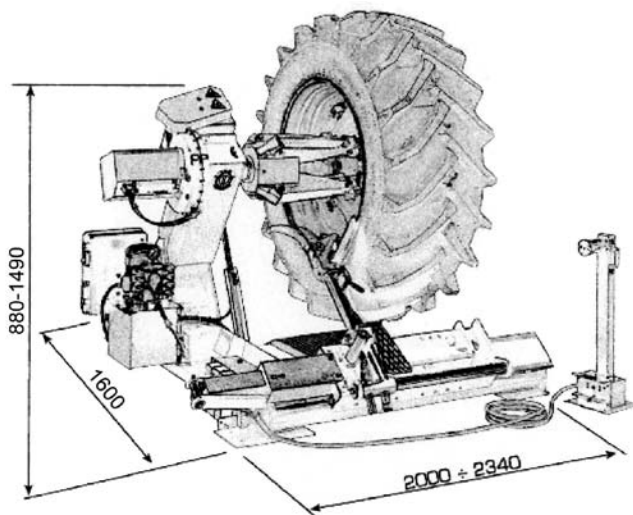



-  • Mandrino autocentrante a due velocità di rotazione (5 - 10 giri/minuto) • Per pneumatici tube e tubeless da 14" a 46" (56" con estensioni opzionali).
-  • Double speed self-centring chuck (5 - 10 rpm) • For tubeless and tube-type tyres from 14" to 46" diameters (56" with optional extensions).
-  • Selbstzentrierendes Universal-Spannfutter mit zwei Drehgeschwindigkeiten (5 - 10 UpM) • Für Reifen mit oder ohne Schlauch von 14" bis 46" Durchmesser (56" mit Sonderaufsätzen).
-  • Mandrin universel à deux vitesses (5 - 10 tours/min.) • Pour pneus avec chambre air et tubeless de 14" à 46" de diamètre (56" avec jeu de rallonges en option).
-  • Autocentrante con dos velocidades (5 - 10 rpm) • Para neumáticos tube y tubeless entre 14" y 46" (56" con extensiones opcionales).





TITANIUM 2000



-  Carrello con movimento idraulico e braccio utensili con traslazione manuale
-  Hydraulically operated carriage, tool holder arm with manual traverse
-  Schlitten mit hydraulischem Antrieb und Montagewerkzeug mit manueller Verfahrsteuerung
-  Chariot à mouvement hydraulique et bras porte-outils à translation manuelle
-  Carro con movimiento hidráulico y brazo para herramientas con traducción manual



-  Unità di controllo portatile
-  Portable control unit
-  Mobile Steuereinheit
-  Unité de commande mobile
-  Unidad de control portátil

 Dati tecnici	 Technical data	 Technische Eigenschaften	 Caractéristiques techniques	 Datos técnico	
Diametro cerchio	Rim diameter	Felgendurchmesser	Diamètre de la jante	Diámetro llanta	14" - 46" - 56"*
Diametro massimo ruota	Max.wheel diameter	Max.Reifendurchmesser	Diamètre max. du pneu	Diámetro máx. rueda	2.300 mm (90")
Larghezza massima ruota	Max.wheel width	Max.Reifenbreite	Largeur max. du pneu	Anchura máx. rueda	1.065 mm (41")
Peso massimo ruota	Max. wheel weight	Max. Radgewicht	Poids max. de la rue	Peso máx. rueda	1.500 Kg
Motore centralina idraulica	Motor of hydraulic pump	Motor der Hydraulikpumpe	Moteur de la pompe hydraulique	Motor centralita hidráulica	1,1 kW
Motore riduttore	Gear motor	Motorleistungdes Getriebes	Moteur du réducteur	Motor reductor	1,3/1,8 kW
Tensione di alimentazione trifase	Feeding tension (3-phase)	Drehstrom-Versorgungsspannung	Tension de alimentation triphasée	Tensión de alimentación (trifásica)	400V 50 Hz - 3 ph
Forza di stallonatura	Bead breaking force	Abdrückkraft	Force du détalonneur	Fuerza de destalonado	15600 N (1.630 Kg)
Pressione di esercizio	Operating pressure	Betriebsdruck	Pression de travail	Presión de servicio	0-130 bar

* Optional

The company reserves the right to introduce improvements in design or specification without prior notice